

# INSTRUCTION MANUAL

## FOR

### REMOTE DISPLAY PANEL

#### RDP-300-4S

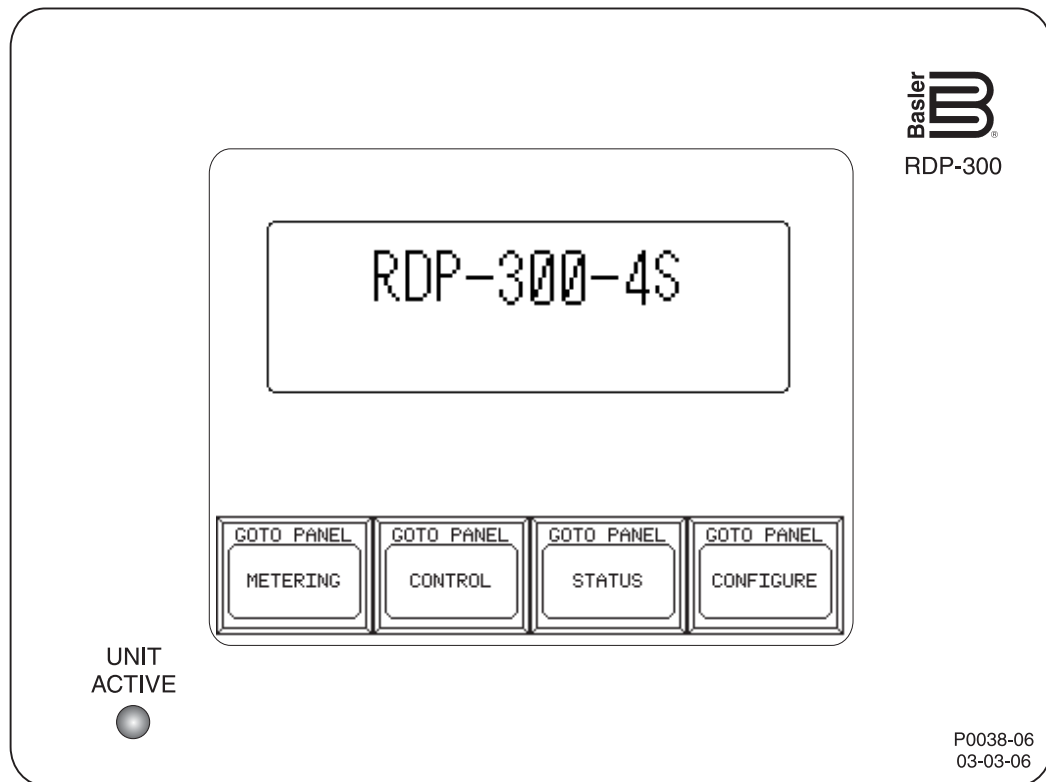

**B** Basler Electric

Publication: 9334500996  
Revision: B 12/08



# INTRODUCTION

---

This instruction manual provides information about the operation and installation of the RDP-300-4S Remote Display Panel. To accomplish this, the following information is provided.

- General Information and Specifications
- Human-Machine Interface
- Functional Description
- Installation
- Troubleshooting

## **WARNING!**

To avoid personal injury or equipment damage, only qualified personnel should perform the procedures in this manual.

## **NOTE**

Be sure that the device is hard-wired to earth ground with no smaller than 12 AWG copper wire attached to the ground terminal on the rear of the unit case. When the RDP-300-4S is configured in a system with other devices, it is recommended to use a separate lead to the ground bus from each unit.

First Printing: March 2006

Printed in USA

Copyright 2008 Basler Electric, Highland Illinois, USA

December 2008

**CONFIDENTIAL INFORMATION**

of Basler Electric, Highland Illinois, USA. It is loaned for confidential use, subject to return on request, and with the mutual understanding that it will not be used in any manner detrimental to the interest of Basler Electric.

It is not the intention of this manual to cover all details and variations in equipment, nor does this manual provide data for every possible contingency regarding installation or operation. The availability and design of all features and options are subject to modification without notice. Should further information be required, contact Basler Electric.

**BASLER ELECTRIC  
ROUTE 143, BOX 269  
HIGHLAND IL 62249 USA**

**<http://www.basler.com>, [info@basler.com](mailto:info@basler.com)**

**PHONE +1 618.654.2341**

**FAX +1 618.654.2351**

## PRODUCT REVISION HISTORY

The following information provides a historical summary of the changes made to the RDP-300-4S hardware. The corresponding revisions made to this instruction manual (9334500996) are also summarized. Revisions are listed in chronological order.

Hardware Revision and Date	Change
A, 03/06	<ul style="list-style-type: none"> <li>• Initial release</li> </ul>
B, 12/08	<ul style="list-style-type: none"> <li>• Bias resistors added to RS-485 communication terminals</li> </ul>

Firmware Version and Date	Change
1.00.00, 03/06	<ul style="list-style-type: none"> <li>• Initial release</li> </ul>

Manual Revision and Date	Change
-, 03/06	<ul style="list-style-type: none"> <li>• Initial release</li> </ul>
A, 10/06	<ul style="list-style-type: none"> <li>• Replaced all optional power supply part number references due to obsolescence of part. Part number 9334503100 changed to 9334503101</li> </ul>
B, 12/08	<ul style="list-style-type: none"> <li>• Revised Figures 4-1 and 4-5 to show updated layout of terminals</li> <li>• Moved all shield connection references from the SHLD terminal to the GND terminal</li> </ul>

This page intentionally left blank.

# CONTENTS

---

SECTION 1 • GENERAL INFORMATION .....	1-1
DESCRIPTION .....	1-1
FEATURES .....	1-1
SPECIFICATIONS .....	1-1
Control Voltage .....	1-1
Display .....	1-1
Communication Port.....	1-1
Environment.....	1-1
Physical.....	1-1
SECTION 2 • HUMAN-MACHINE INTERFACE .....	2-1
CONTROLS AND INDICATORS.....	2-1
Unit Active Indicator .....	2-1
Touch Screen.....	2-1
SECTION 3 • FUNCTIONAL DESCRIPTION .....	3-1
INTRODUCTION .....	3-1
POWER SUPPLY .....	3-1
MICROPROCESSOR CONTROLLER .....	3-1
Firmware .....	3-1
TOUCH SCREEN INTERFACE.....	3-1
Navigation .....	3-1
Screen Title Bars.....	3-1
Setpoint Entry.....	3-3
Screen Descriptions.....	3-3
Title Screen .....	3-3
Metering Header Screen .....	3-3
DECS Metering Screen 1 .....	3-3
DECS Metering Screen 2.....	3-4
Control Header Screen.....	3-4
DECS Setpoint Control Screen.....	3-4
DECS Mode Control Screen .....	3-5
DECS AVR/FCR Confirmation Screen.....	3-6
DECS Setpoint Entry Screen .....	3-7
Status Header Screen.....	3-7
DECS Status Screen 1.....	3-8
DECS Status Screen 2.....	3-8
DECS Status Screen 3.....	3-8
DECS Alarm Screen 1.....	3-9
DECS Alarm Screen 2.....	3-10
Configure Header Screen .....	3-11
Time, Date, and Display Contrast Adjustment Screen.....	3-11
RS-485 INTERFACE .....	3-12
SECTION 4 • INSTALLATION .....	4-1
UNPACKING AND STORAGE .....	4-1
HARDWARE .....	4-1
MOUNTING .....	4-1
Installation Guidelines.....	4-1
Ventilation.....	4-1
Electrical Interference.....	4-1
Mounting.....	4-1

SECTION 4 • INSTALLATION—continued	
Miscellaneous.....	4-1
Mounting Instructions.....	4-3
RDP-300 Power Supply.....	4-4
CONNECTIONS.....	4-5
RS-485 Terminating Resistors.....	4-6
COMMUNICATION SETUP.....	4-6
SECTION 5 • TROUBLESHOOTING.....	5-1
TROUBLESHOOTING PROCEDURES.....	5-1

# SECTION 1 • GENERAL INFORMATION

---

## DESCRIPTION

The RDP-300-4S Remote Display Panel uses microprocessor-based technology to provide remote control and annunciation status of a single DECS-400 Digital Excitation Control System. The touch-sensitive display panel communicates with the DECS-400 through an RS-485 port using Modbus™ communication protocol. RS-485 communication ensures noise immunity even over long distances.

The RDP-300-4S display menu consists of metering and status screens, control screens, and a configuration screen. The simple display menu structure makes screen navigation fast and easy.

---

## FEATURES

RDP-300-4S Remote Display Panels have the following features.

- Six inch (diagonal) monochrome liquid crystal display (LCD) with fluorescent backlight
  - Touch screen withstands hard use
  - Low power consumption
  - NEMA 12/4 rating
- 

## SPECIFICATIONS

RDP-300 Remote Display Panels have the following specifications.

### Control Voltage

Input:	24 Vdc $\pm$ 15%
Power Dissipation:	20 W
Terminals:	V+, V–

### Display

Type:	Monochrome LCD with fluorescent backlight
Size:	6 in (152 mm), measured diagonally
Resolution:	320 (wide) by 240 (high)
Color:	Blue and white

### Communication Port

Type:	RS-485
Baud Rate:	9600
Data Bits:	8
Parity:	None
Stop Bits:	2
Response Time Delay:	10 ms
Terminals:	A, B, C

### Environment

Temperature	
Operating:	0 to 45°C (32 to 113°F)
Storage:	–20 to 60°C (–4 to 140°F)
Humidity:	20 to 85%, non-condensing
NEMA Rating:	12/4 (self-certified)

### Physical

Dimensions:	See Section 4, <i>Installation</i>
Weight:	750 g (1.65 lb)

This page intentionally left blank.

# SECTION 2 • HUMAN-MACHINE INTERFACE

## CONTROLS AND INDICATORS

RDP-300-4S controls and indicators are located on the front of the display panel and consist of a Unit Active indicator and a touch-sensitive display screen. RDP-300-4S controls and indicators are shown in Figure 2-1.

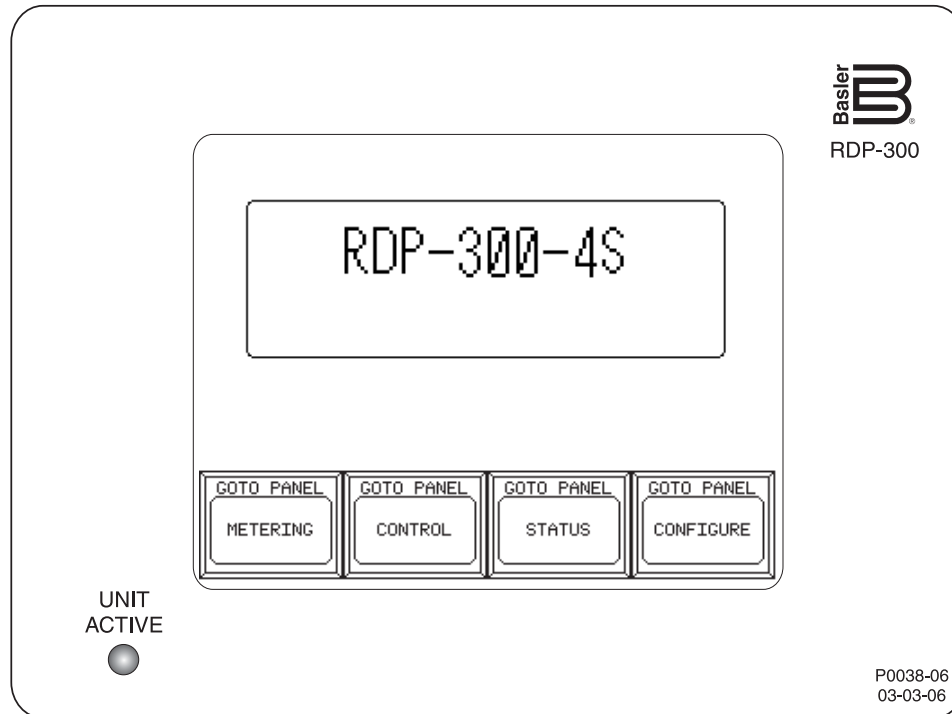

Figure 2-1. RDP-300-4S Human-Machine Interface

### Unit Active Indicator

This green LED lights when operating power is applied to the RDP-300-4S.

### Touch Screen

The touch screen consists of a blue and white, touch-sensitive LCD panel with fluorescent backlighting. It measures six inches diagonally and has a resolution of 320 pixels (wide) by 240 pixels (high).

The touch screen functions as an indicator by displaying DECS-400 settings and metering and status parameters. It functions as a control by accepting touch inputs to select menu displays and make settings changes.

Touch screen menu navigation and function is described in Section 3, *Functional Description*.

This page intentionally left blank.

# SECTION 3 • FUNCTIONAL DESCRIPTION

## INTRODUCTION

The microprocessor-controlled RDP-300-4S provides remote annunciation and control of a single DECS-400 Digital Excitation Control System. Annunciation and control is provided by a touch-sensitive display panel. An RS-485 interface using Modbus™ protocol provides serial communication between the RDP-300-4S and DECS-400.

RDP-300-4S function is illustrated in Figure 3-1 and described in the following paragraphs.

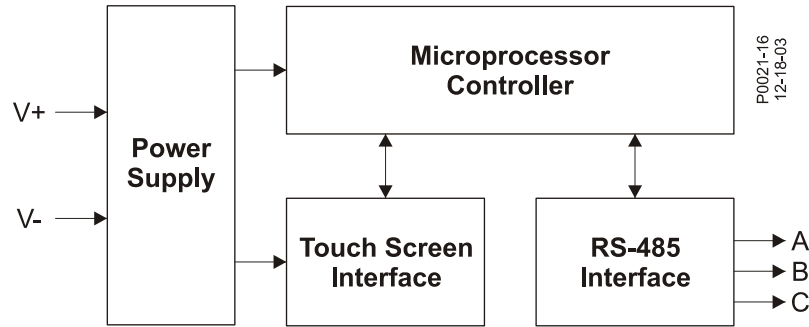

Figure 3-1. RDP-300-4S Function Block Diagram

## POWER SUPPLY

Operating power for the RDP-300-4S circuitry is provided by the power supply. The power source for the RDP-300-4S power supply connects to terminals V+ and V- and should provide 24 Vdc ( $\pm 15\%$ ) at 20 watts.

## MICROPROCESSOR CONTROLLER

The microprocessor performs annunciation and control functions by the use of firmware embedded in the RDP-300-4S.

### Firmware

Embedded firmware controls all RDP-300-4S functions. This includes power-up initialization, touch screen setup, configuration, and serial communication input monitoring. Upon RDP-300-4S power-up, the firmware initiates a power-up sequence, checks internal memory, activates all functions, begins input monitoring, and displays the title screen.

## TOUCH SCREEN INTERFACE

The touch screen provides the interface for all available DECS-400 control and annunciation functions. The touch screen consist of a blue and white, touch-sensitive LCD panel with fluorescent backlighting. The touch screen measures six inches diagonally and has a resolution of 320 pixels (wide) by 240 pixels (high).

### Navigation

Screen navigation is achieved by pressing the labeled, touch sensitive areas of the display. Figure 3-2 illustrates the touch screen navigation map.

#### Screen Title Bars

Each status and setpoint entry screen accessed through the Metering, Control, and Status header screens is labeled with a title bar. The title bar flashes when a DECS-400 alarm exists. Pressing the title bar displays the DECS Alarms screen with the active alarm (either DECS Alarm Screen 1 or 2). Pressing the flashing button on the screen with the active alarm displays the most recently viewed screen.

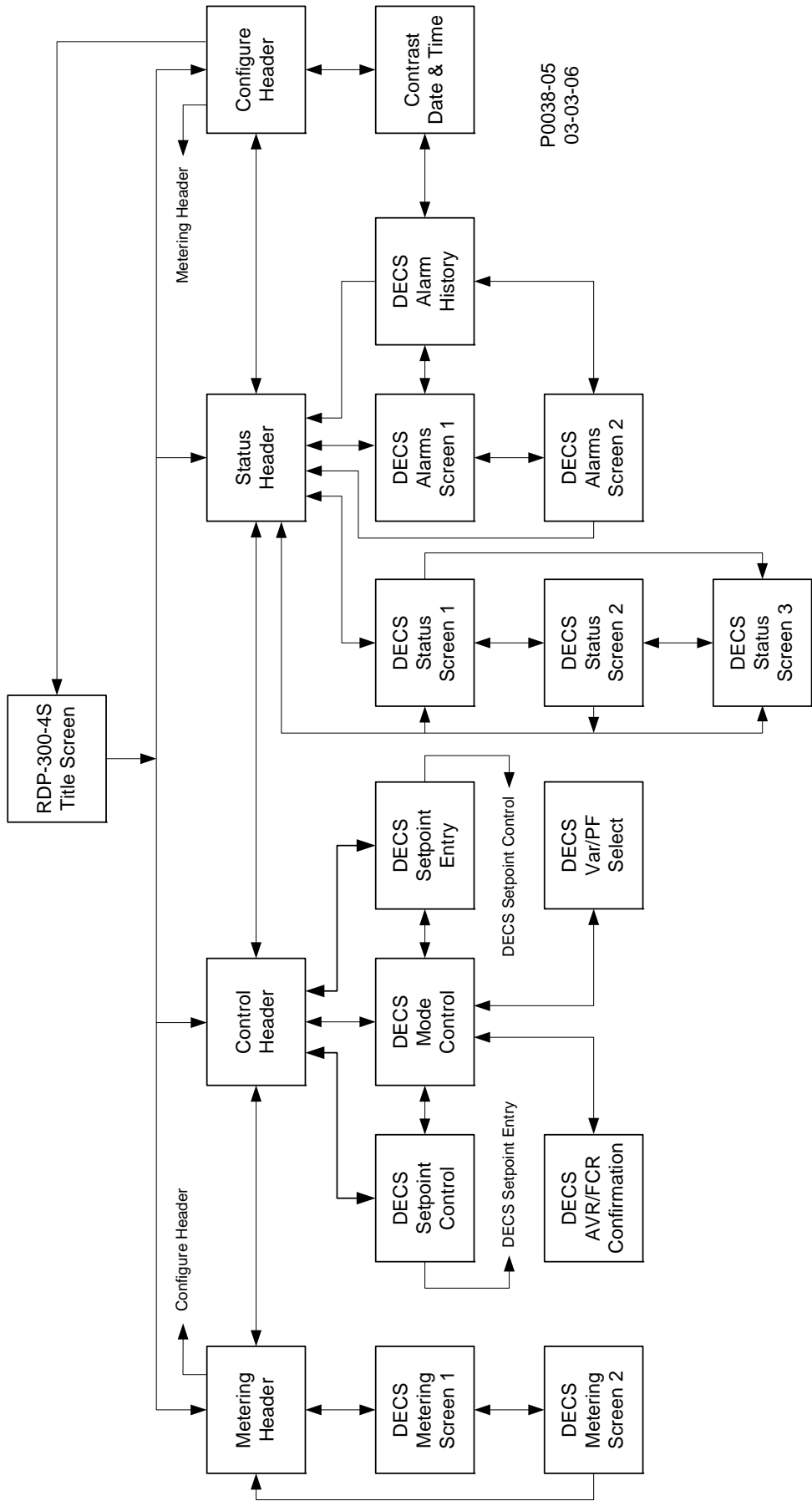

Figure 3-2. Touch Screen Navigation Map

### Setpoint Entry

Entry of a DECS-400 setpoint is achieved through the corresponding Setpoint Entry screen. Pressing one of the numeric setpoint buttons displays a screen similar to the FCR Setpoint screen shown in Figure 3-3. The setpoint screen indicates the minimum and maximum setpoint limits and has a numeric keypad for setpoint entry. Displayed minimum and maximum setpoint limits are based on values retained by the RDP-300-4S. The actual minimum and maximum setpoint limits may be affected by other DECS-400 settings. If an entered value is outside the DECS-400 setting range, the DECS Setpoint Entry screen will not be updated. Pressing the Enter key enters the value in the screen's Current Value field. Pressing the Done key displays the Setpoint Entry screen with the new setpoint indicated.

FCR SETPOINT				
Current Value:		10.00		
		Maximum >>> 12000.0		
		10.00		
P0022-09 02-02-04		Minimum >>> 0.00		
1	2	3	+/-	Del
4	5	6	-	Enter
7	8	9	0	Done

Figure 3-3. DECS Setpoint Entry Screen

### **Screen Descriptions**

The following paragraphs describe the function of each RDP-300-4S screen.

#### Title Screen

The title screen is displayed upon power-up of the RDP-300-4S. It indicates the display panel model number and firmware version number. Buttons along the bottom of the screen provide access to the Metering header screen, Control header screen, Status header screen, and Configure header screen.

#### Metering Header Screen

The Metering header screen provides access to DECS Metering Screen 1, the Control header screen, and the Configure header screen.

#### DECS Metering Screen 1

DECS Metering Screen 1 (Figure 3-4) displays the following metered values and provides access to DECS Metering Screen 2.

*GENERATOR VOLTAGE*. Indicates the average of the three rms line-to-line generator voltages.

*GENERATOR kWATTS*. Indicates the level of real power (in kilowatts) that the generator is supplying.

*GENERATOR KVAR*. Indicates the level of reactive power (in kilovars) that the generator is supplying.

*GENERATOR PF*. Indicates the ratio of the generator real power level to the generator apparent power level.

*MAIN/EXCITER FIELD VOLTAGE*. Indicates the level of excitation voltage (in volts) being supplied to the field.

*MAIN/EXCITER FIELD CURRENT*. Indicates the level of excitation current (in amperes) being supplied to the field.

*GENERATOR CURRENT*. Indicates the average of the metered rms current in amperes.

*GENERATOR FREQUENCY*. Indicates the generator frequency in hertz.

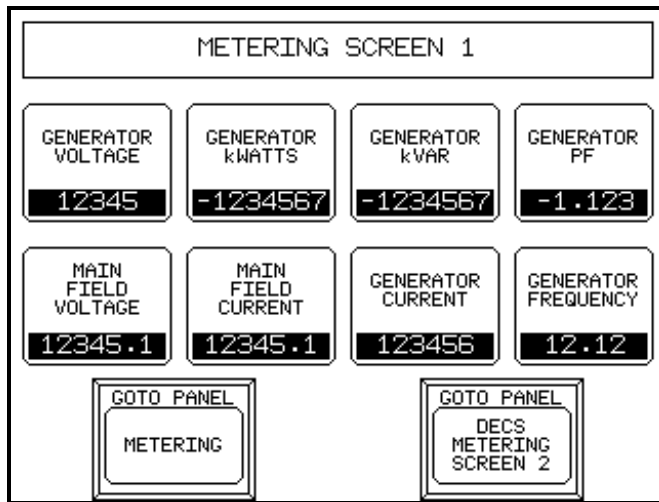

Figure 3-4. DECS Metering Screen 1

DECS Metering Screen 2

DECS Metering Screen 2 (Figure 3-5) displays the following metered values.

**GENERATOR kVA.** Indicates the level of apparent power that the generator is supplying.

**AUXILIARY INPUT VOLTAGE.** Indicates the voltage level present at the DECS-400 Accessory input when remote setpoint control is used.

**BUS VOLTAGE.** Indicates the rms value of bus voltage measured by the DECS-400.

**BUS FREQUENCY.** Indicates the frequency (in hertz) of the bus voltage.

**SETPOINT POSITION PERCENTAGE.** Indicates the active DECS-400 operating setpoint expressed as a percentage of its adjustment range.

**TRACKING/NUL ERROR.** Indicates the difference, in percent, between the setpoint of the tracking mode and the setpoint of the mode being tracked.

**FIELD TEMP.** Indicates the field temperature, in degrees Fahrenheit, calculated by the DECS-400.

**PSS OUTPUT SIGNAL.** Indicates the per-unit output of the power system stabilizer.

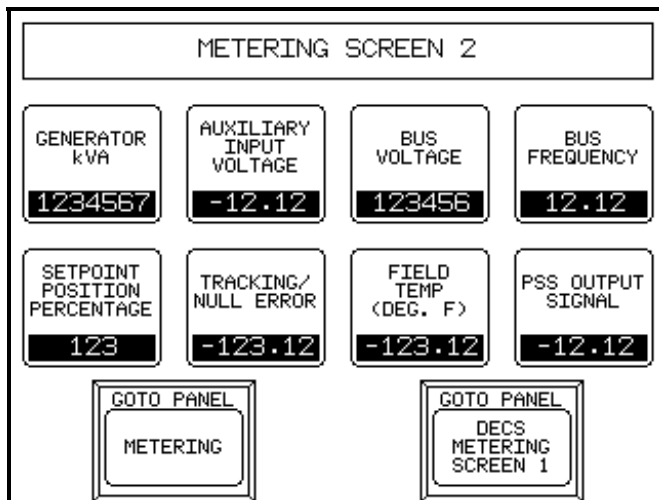

Figure 3-5. DECS Metering Screen 2

Control Header Screen

The Control header screen provides access to the DECS Setpoint Control screen (DECS R/L Control button), DECS Mode Control screen, the Status header screen, and the Metering header screen.

DECS Setpoint Control Screen

The DECS Setpoint Control screen (Figure 3-6) provides the following metering and control functions and provides access to the DECS Mode Control screen and DECS Setpoint Entry screen.

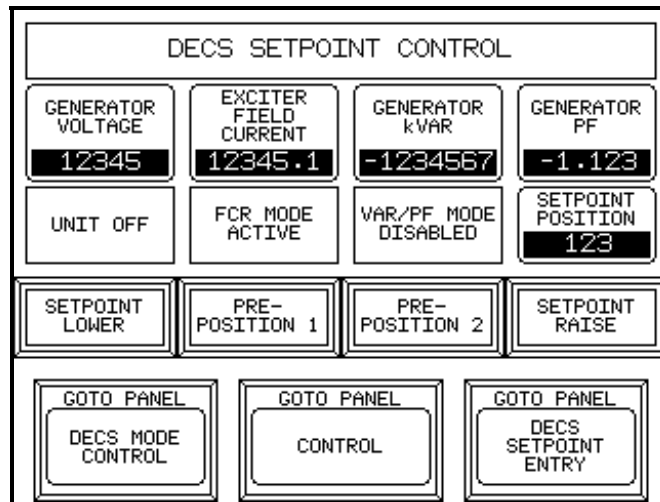

Figure 3-6. DECS Setpoint Control Screen

**GENERATOR VOLTAGE.** Indicates the average of the three line-to-line, rms generator voltages.

**MAIN/EXCITER FIELD CURRENT.** Indicates the level of excitation current (in amperes) being supplied to the field.

**GENERATOR kVAR.** Indicates the level of reactive power (in kilovars) that the generator is supplying.

**GENERATOR PF.** Indicates the ratio of the generator real power level to the generator apparent power level.

**UNIT OFF/UNIT ON.** Indicates the DECS-400 on/off status.

**AVR MODE ACTIVE/FCR MODE ACTIVE.** Indicates whether the DECS-400 is operating in AVR mode or FCR mode.

**PF MODE ENABLED/VAR MODE ENABLED/VAR/PF MODE DISABLED.** Indicates whether the DECS-400 has Power Factor mode enabled, Var mode enabled, or both modes disabled.

**SETPOINT POSITION.** Indicates the DECS-400 active, operating setpoint expressed as a percentage of the adjustment range.

**SETPOINT LOWER.** Pressing this button decreases the DECS-400 voltage setpoint. The lower increment is a function of the setpoint adjustment range and the active traverse rate. The increments are directly proportional to the adjustment range and inversely proportional to the traverse rate. This button is highlighted when the setpoint is at the lower limit.

**PRE-POSITION 1.** Pressing this button changes the DECS-400 setpoint to the pre-position 1 value. The button is highlighted when the setpoint is at the pre-position 1 value. Pre-Position button function depends on the DECS-400 pre-position mode. Refer to the DECS-400 instruction manual (9369700990) for more information.

**PRE-POSITION 2.** Pressing this button changes the DECS-400 setpoint to the pre-position 2 value. The button is highlighted when the setpoint is at the pre-position 2 value. Pre-Position button function depends on the DECS-400 pre-position mode. Refer to the DECS-400 instruction manual (9369700990) for more information.

**SETPOINT RAISE.** Pressing this button increases the DECS-400 voltage setpoint. The raise increment is a function of the setpoint adjustment range and the active traverse rate. The increments are directly proportional to the adjustment range and inversely proportional to the traverse rate. This button is highlighted when the setpoint is at the upper limit.

#### DECS Mode Control Screen

The DECS Mode Control screen (Figure 3-7) provides the following metering and control functions and provides access to the DECS Setpoint Control screen and DECS Setpoint Entry screen.

**GENERATOR VOLTAGE.** Indicates the average of the three line-to-line, rms generator voltages.

**MAIN/EXCITER FIELD CURRENT.** Indicates the level of excitation current (in amperes) being supplied to the field.

**GENERATOR kVAR.** Indicates the level of reactive power (in kilovars) that the generator is supplying.

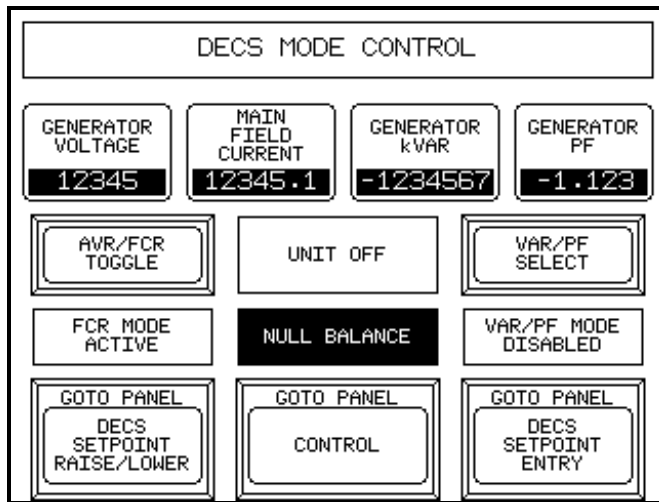

Figure 3-7. DECS Mode Control Screen

**GENERATOR PF.** Indicates the ratio of the generator real power level to the generator apparent power level.

**AVR/FCR TOGGLE.** Pressing this button displays the DECS AVR/FCR Confirmation screen (Figure 3-8), which is described in the paragraphs under *DECS AVR/FCR Confirmation Screen*.

**UNIT OFF/UNIT ON.** Indicates the DECS-400 on/off status.

**VAR/PF SELECT.** Pressing this button displays the DECS Var/Power Factor Select screen. This screen indicates the Var/Power Factor mode status (Var mode enabled, PF mode enabled, or Var/PF mode disabled) and has buttons for enabling Var mode, enabling PF mode, and disabling both modes. Pressing the CANCEL, RETURN TO PREVIOUS SCREEN button aborts the Var/Power Factor mode change and displays the DECS Mode Control screen.

**AVR MODE ACTIVE/FCR MODE ACTIVE.** Indicates whether the DECS-400 is operating in AVR mode or FCR mode.

**NULL BALANCE/NULL UNBALANCE.** Indicates whether a null balance or null imbalance condition exists. (A null balance condition exists when the setpoint of the DECS-400 inactive operating mode is within 1% of the setpoint of the DECS-400 active mode.)

**PF MODE ENABLED/VAR MODE ENABLED/VAR/PF MODE DISABLED.** Indicates whether the DECS-400 has Power Factor mode enabled, Var mode enabled, or both modes disabled.

DECS AVR/FCR Confirmation Screen

This screen (Figure 3-8) requires the user to confirm an AVR/FCR mode change before the change is implemented. The DECS AVR/FCR Confirmation screen displays an AVR button when the DECS-400 is in FCR mode and an FCR button when the DECS-400 is in AVR mode. If the DECS-400 is in AVR mode, pressing the FCR button will place the DECS-400 in FCR mode. If the DECS-400 is in FCR mode, pressing the AVR button will place the DECS-400 in AVR mode. This button is highlighted when a null balance condition exists. (A null balance condition exists when the setpoint of the DECS-400 inactive operating mode is within 1% of the setpoint of the DECS-400 active mode.) Pressing the CANCEL, RETURN TO PREVIOUS SCREEN button aborts the AVR/FCR mode change and displays the DECS Mode Control screen.

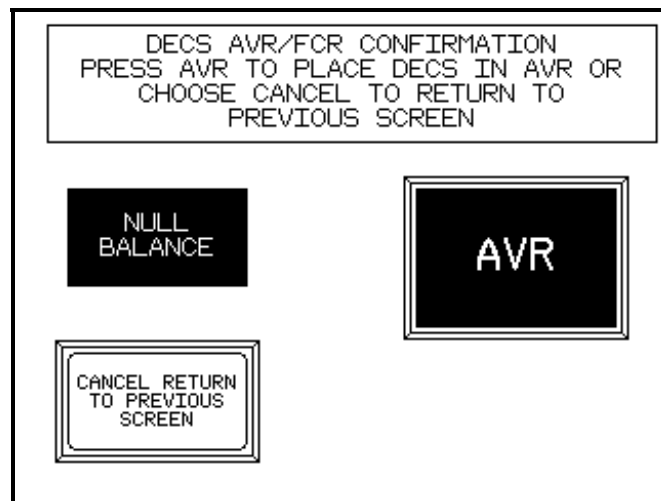

Figure 3-8. DECS Setpoint Entry Screen

An indicator box on the DECS AVR/FCR Confirmation screen indicates whether a null balance or null imbalance condition exists. (A null balance condition exists when the setpoint of the DECS-400 inactive operating mode is within 1% of the setpoint of the DECS-400 active mode.)

### DECS Setpoint Entry Screen

The DECS Setpoint Entry screen (Figure 3-9) provides the following metering and setpoint entry functions and provides access to the DECS Setpoint Control screen and DECS Mode Control screen.

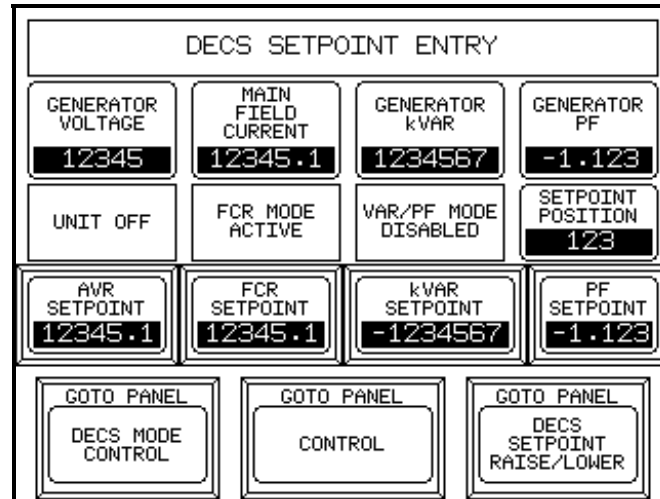

Figure 3-9. DECS Setpoint Entry Screen

**GENERATOR VOLTAGE.** Indicates the average of the three line-to-line, rms generator voltages.

**MAIN/EXCITER FIELD CURRENT.** Indicates the level of excitation current (in amperes) being supplied to the field.

**GENERATOR kVAR.** Indicates the level of reactive power (in kilovars) that the generator is supplying.

**GENERATOR PF.** Indicates the ratio of the generator real power level to the generator apparent power level.

**UNIT OFF/UNIT ON.** Indicates the DECS-400 on/off status.

**AVR MODE ACTIVE/FCR MODE ACTIVE.** Indicates whether the DECS-400 is operating in AVR mode or FCR mode.

**PF MODE ENABLED/VAR MODE ENABLED/VAR/PF MODE DISABLED.** Indicates whether the DECS-400 has Power Factor mode enabled, Var mode enabled, or both modes disabled.

**SETPOINT POSITION.** Indicates the DECS-400 active operating setpoint expressed as a percentage of the adjustment range.

**AVR SETPOINT.** Indicates the DECS-400 AVR setpoint in volts. Pressing this button displays the AVR Setpoint screen which allows adjustment of the AVR setpoint. See *Touch Screen Interface, Setpoint Entry* for details about setpoint entry.

**FCR SETPOINT.** Indicates the DECS-400 FCR setpoint in amperes. Pressing this button displays the FCR Setpoint screen which allows adjustment of the FCR setpoint. See *Touch Screen Interface, Setpoint Entry* for details about setpoint entry.

**kVAR SETPOINT.** Indicates the DECS-400 reactive power setpoint in kilovars. Pressing this button displays the kVar Setpoint Screen which allows adjustment of the reactive power setpoint. See *Touch Screen Interface, Setpoint Entry* for details about setpoint entry.

**PF SETPOINT.** Indicates the generator power factor setpoint. Pressing this button displays the PF Setpoint screen which allows adjustment of the power factor. See *Touch Screen Interface, Setpoint Entry* for details about setpoint entry.

### Status Header Screen

The Status header screen provides access to DECS Status screen 1, DECS Alarms screen 1, the Configure header screen, and the Control header screen.

### DECS Status Screen 1

DECS Status screen 1 (Figure 3-10) indicates the state of the following DECS-400 inputs and features and provides access to DECS Status screen 2, DECS Status screen 3, and the Status header screen.

- External tracking enabled
- Internal tracking enabled
- PSS active
- Secondary OEL group active
- Secondary PID group active
- Secondary protection group active
- Secondary PSS group active
- Secondary soft-start active
- Secondary stator current limiter group active
- Secondary UEL group active
- Selected as secondary DECS-400
- Voltage matching on

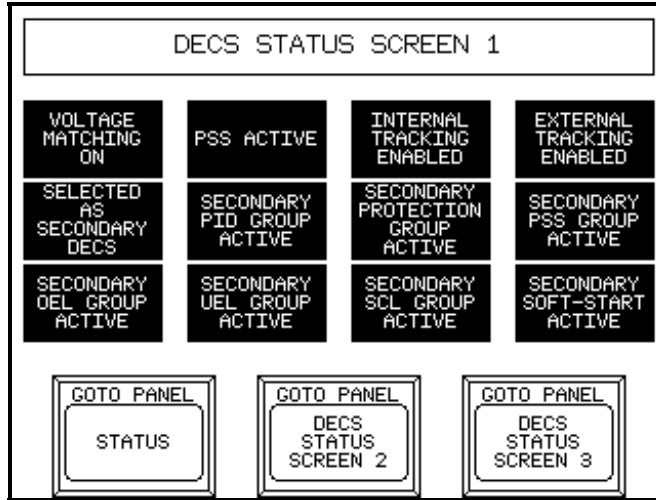

Figure 3-10. DECS Status Screen 1

### DECS Status Screen 2

DECS Status screen 2 (Figure 3-11) indicates the state of the following DECS-400 inputs and features and provides access to DECS Status screen 1, DECS Status screen 3, and the Status header screen.

- DECS-400 clock reset
- DECS-400 Edit indicator on
- Loss of IRIG signal
- Low power supply voltage
- Null balance/unbalance
- Setpoint at pre-position 1 value
- Setpoint at pre-position 2 value
- System frequency below 10 Hz

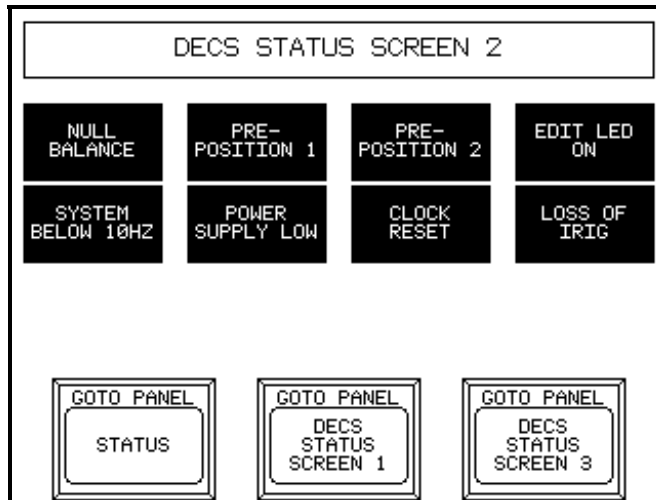

Figure 3-11. DECS Status Screen 2

### DECS Status Screen 3

DECS Status screen 3 (Figure 3-12) indicates the open/closed state of the following DECS-400 contact inputs and outputs and provides access to DECS Status screen 1, DECS Status screen 2, and the Status header screen.

- AVR output contact
- Contact input 1
- Contact input 2
- Contact input 3
- Contact input 4
- Contact input 5
- Contact input 6
- Contact input 7
- Contact input 8
- Contact input 9
- Contact input 10
- FCR output contact
- Lower output contact
- Raise output contact
- Start output contact
- Stop output contact

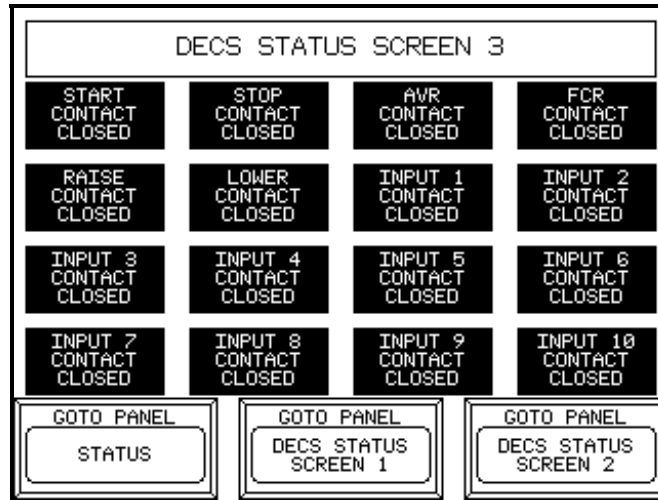

Figure 3-12. DECS Status Screen 3

DECS Alarm Screen 1

DECS Alarms screen 1 (Figure 3-13) annunciates the following DECS-400 alarms and provides access to DECS Alarm screen 2, the DECS Alarm History screen, and the Status header screen.

- Excessive volts per hertz
- Field overcurrent
- Field overtemperature
- Field overvoltage
- Generator overvoltage
- Generator undervoltage
- Loss of field
- Loss of sensing
- Overexcitation limiter active
- Stator current limiter active
- Underexcitation limiter active
- Underfrequency limiter active

**ALARM RESET.** Pressing this button clears DECS-400 alarms that are no longer active.

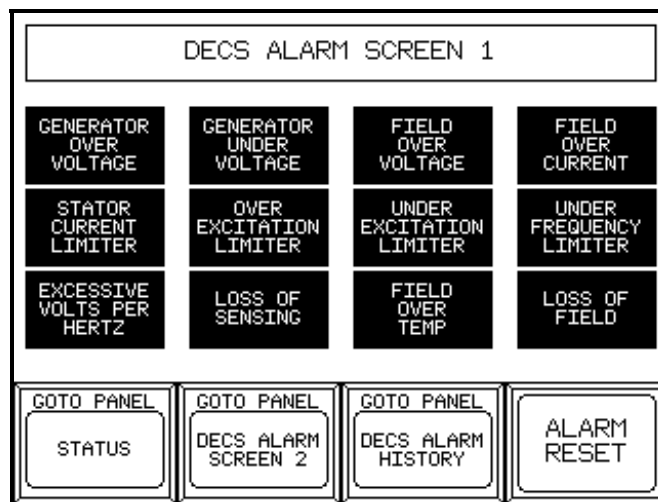

Figure 3-13. DECS Alarms Screen 1

### DECS Alarm Screen 2

DECS Alarm screen 2 (Figure 3-14) annunciates the following DECS-400 alarms and provides access to DECS Alarm screen 1, the DECS Alarm History screen, and the Status header screen.

- Loss of isolation module
- Open exciter diode
- Power below PSS threshold
- PSS speed failure
- PSS voltage limiter active
- Shorted exciter diode
- Unbalanced PSS current
- Unbalanced PSS voltage
- Voltage failed to build

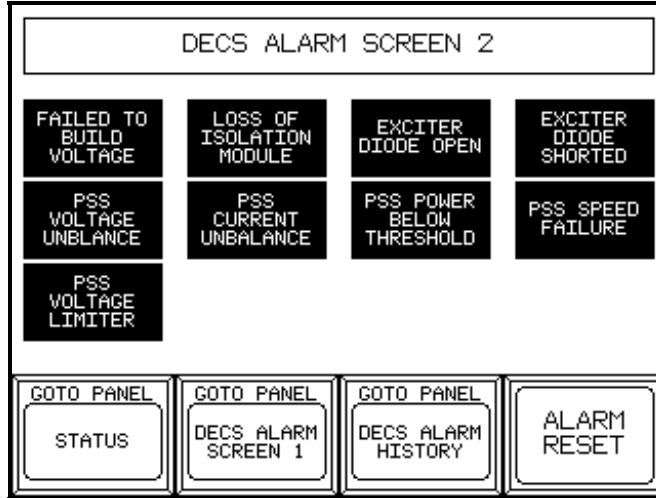

Figure 3-14. DECS Alarm Screen 2

### DECS Alarm History Screen

The DECS Alarm History screen (Figure 3-15) lists all DECS-400 alarms logged by the RDP-300-4S and provides access to the Time, Date, and LCD Contrast Adjustment screen, DECS Alarm screen 1, DECS Alarm screen 2, the Status header screen, and Alarm Maintenance screen.

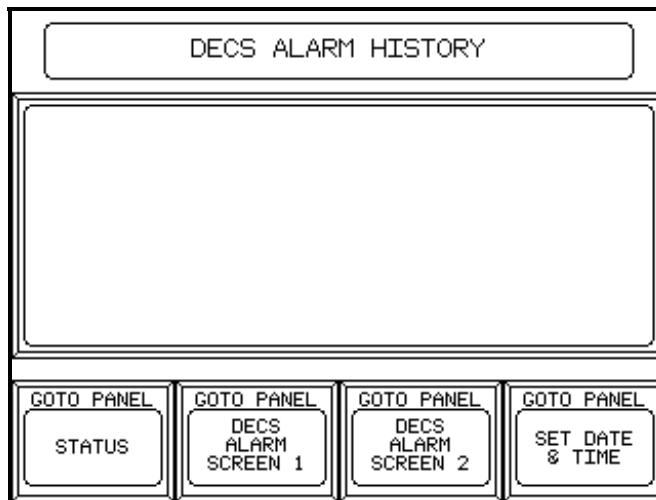

Figure 3-15. DECS Alarm History Screen

**ALARM WINDOW.** This window displays up to 128 alarms logged by the DECS-400. Subsequent logged alarms overwrite the oldest alarms in the window. Alarms are stamped with the date and time kept by the RDP-300-4S. The RDP-300-4S must be configured with the correct date and time to ensure accurate alarm reporting.

Pressing anywhere in the alarm window displays an Alarm Maintenance screen where alarm records can be navigated, acknowledged, or deleted.

To navigate through alarm records, press the Mode button followed by the Up or Down buttons to scroll up or down through the list of alarm records.

To acknowledge alarm records, press the Mode button, navigate to the desired record and press the Ack button. To acknowledge all records, press the Ack All button.

To delete alarm records, press the Mode button, navigate to the record to be deleted, and press the Del button to delete the record. To delete all records, press the Del All button.

To exit the Alarm Maintenance screen and return to the DECS Alarm History screen, press the DONE button.

### Configure Header Screen

The Configure header screen provides access to the Time, Date, and LCD Contrast Adjustment screen, Title screen, Status header screen, and Metering header screen.

### Time, Date, and Display Contrast Adjustment Screen

The date and time kept by the RDP-300-4S is displayed at the top of this screen (Figure 3-13). The date, time, and display contrast are adjusted by using the following buttons.

**SET RDP MONTH.** This button displays the month (in numeric format) retained by the RDP-300-4S clock. Pressing this button displays the System Month Setting screen which allows adjustment of the month portion of the date. See *Touch Screen Interface, Setpoint Entry* for details about making setting changes.

**SET RDP DAY.** This button displays the day of the month retained by the RDP-300-4S clock. Pressing this button displays the System Day Setting screen which allows adjustment of the day portion of the date. See *Touch Screen Interface, Setpoint Entry* for details about making setting changes.

**SET RDP YEAR.** This button displays the year retained by the RDP-300-4S clock. Pressing this button displays the System Year Setting screen which allows adjustment of the year portion of the date. Only the last two digits of the four-digit year designation need to be entered.

**SET RDP HOUR.** This button displays the hour (in 24-hour format) retained by the RDP-300-4S clock. Pressing this button displays the System Hour Setting screen which allows adjustment of the hours portion of the time.

**SET RDP MINUTE.** This button displays the minutes retained by the RDP-300-4S clock. Pressing this button displays the System Minutes Setting screen which allows adjustment of the minutes portion of the time.

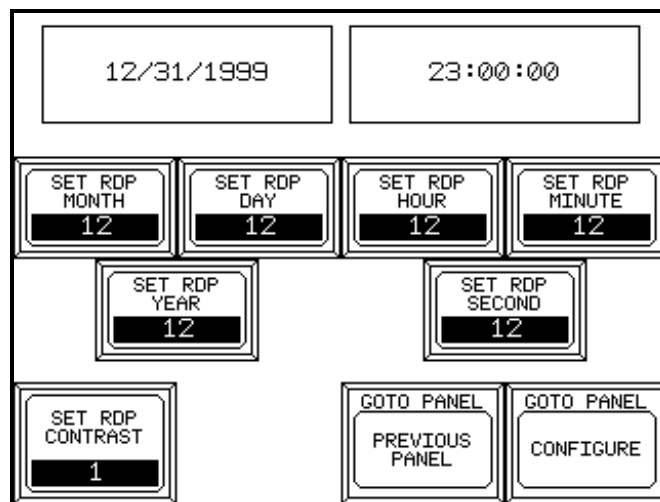

Figure 3-3-16. Time, Date, and Display Contrast Adjustment Screen

**SET RDP SECOND.** This button displays the seconds retained by the RDP-300-4S clock. Pressing this button displays the System Seconds Setting screen which allows adjustment of the seconds portion of the time.

**SET RDP CONTRAST.** This button displays the contrast setting of the touch screen and accesses the Set RDP Contrast screen. Eight contrast settings (0 through 7) are available.

---

## RS-485 INTERFACE

The RS-485 communication interface uses the Modbus™ protocol and enables the RDP-300-4S to communicate with a DECS-400 located up to 4000 feet (1219 meters) away. The differential RS-485 communication signal is converted to a single-ended signal compatible with the microprocessor. Because the RDP-300-4S communication parameters are fixed, the DECS-400 communication settings must be set to match the RDP-300-4S. Table 3-1 lists the DECS-400 parameters required for communication with the RDP-300-4S.

*Table 3-1. DECS-400 Communication Parameters*

<b>Parameter</b>	<b>Setting</b>
Address	247
Baud Rate	9600
Data Bits	8
Parity	None
Stop Bits	2

RS-485 interface connections are made at terminals D9 (A2), D10 (B2), and D11 (C2).

# SECTION 4 • INSTALLATION

---

## UNPACKING AND STORAGE

Upon receipt, unpack the RDP-300-4S and inspect for shipping damage. If there is evidence of damage, file a claim with the carrier and notify Basler Electric.

If the RDP-300-4S won't be installed immediately, store it in the original shipping carton in a moisture- and dust-free environment.

---

## HARDWARE

RDP-300-4S Remote Display Panels are packaged in NEMA 12/4 rated cases that provide a degree of protection against circulating dust, falling debris, and dripping non-corrosive liquids. These panels are suitable for semi-flush mounting in building interiors or exteriors.

Mounting clamps for the RDP-300-4S are packed inside the shipping cartons.

---

## MOUNTING

RDP-300-4S dimensions are shown in Figure 4-1 and a panel cutting diagram is shown in Figure 4-2.

### Installation Guidelines

To protect the RDP-300-4S, provide accessibility, and improve ventilation, observe the following installation guidelines.

#### Ventilation

- Provide at least 4 inches (100 millimeters) of clearance between the RDP-300-4S and other devices and structures.
- The RDP-300-4S should be installed vertically for natural air cooling. If the RDP-300-4S is mounted on a slanted panel, the panel slope should be within 30 degrees of the vertical position.
- Ensure that heat from other equipment does not add heat to the RDP-300-4S. Forced air cooling is required if the RDP-300-4S is used in an environment where the ambient temperature exceeds 50°C (122°F).

#### Electrical Interference

- Ensure that the RDP-300-4S is located away from electromagnetic circuits, circuit breakers, and other arc-producing equipment.
- Route all signal wiring in a separate duct, away from power circuits.
- Use shielded cable and connect the shield to ground.

#### Mounting

- The RDP-300-4S is held in place by metal clamps that accommodate a panel thickness of 0.063 to 0.197 inches (1.6 to 5 millimeters). The clamp screws should be tightened to a torque of 4.4 to 5.3 in-lb (0.5 to 0.6 N•m).

#### Miscellaneous

- Do not hit or apply excessive force to the touch panel.
- Do not use paint thinner or organic solvents to clean the display.

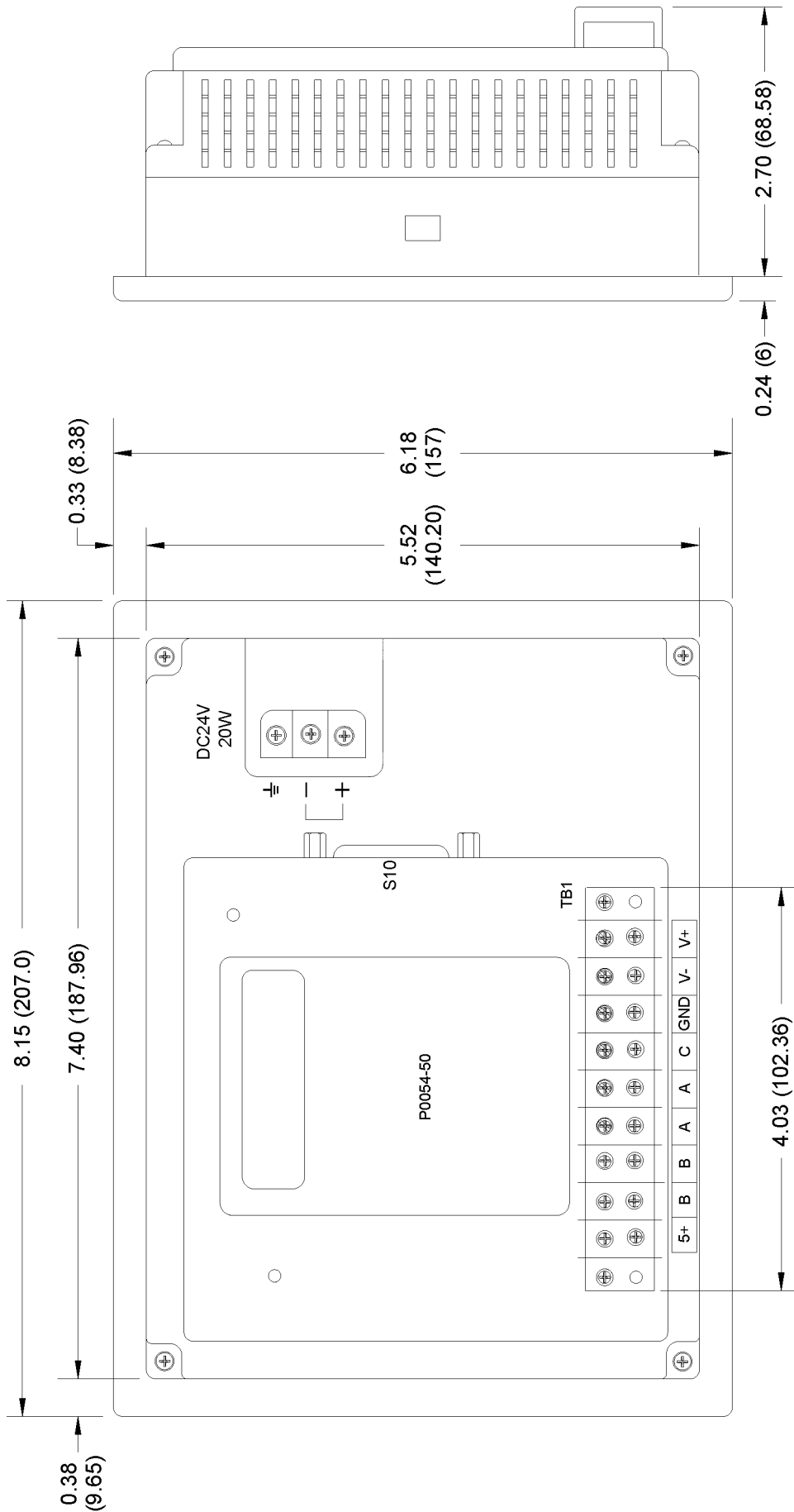

Figure 4-1. RDP-300-4S Dimensions

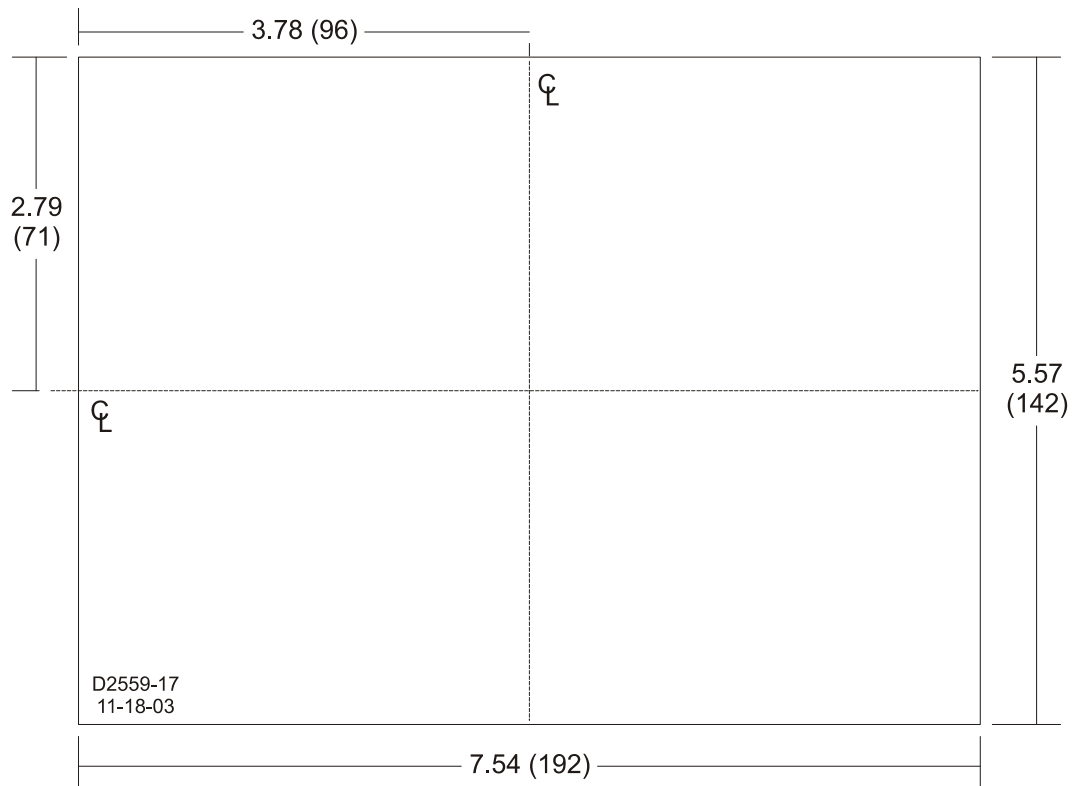

Figure 4-2. RDP-300-4S Panel Cutout Dimensions

### Mounting Instructions

1. Insert the display through the panel opening. Ensure that the flat gasket remains in the faceplate slot as shown in Figure 4-3.
2. Insert the panel clamps in the mounting recess of the display body.
3. Turn the clamp screws clockwise to secure the display against the panel. The clamp screws should be tightened to a torque of 4.4 to 5.3 in-lb (0.5 to 0.6 N•m).

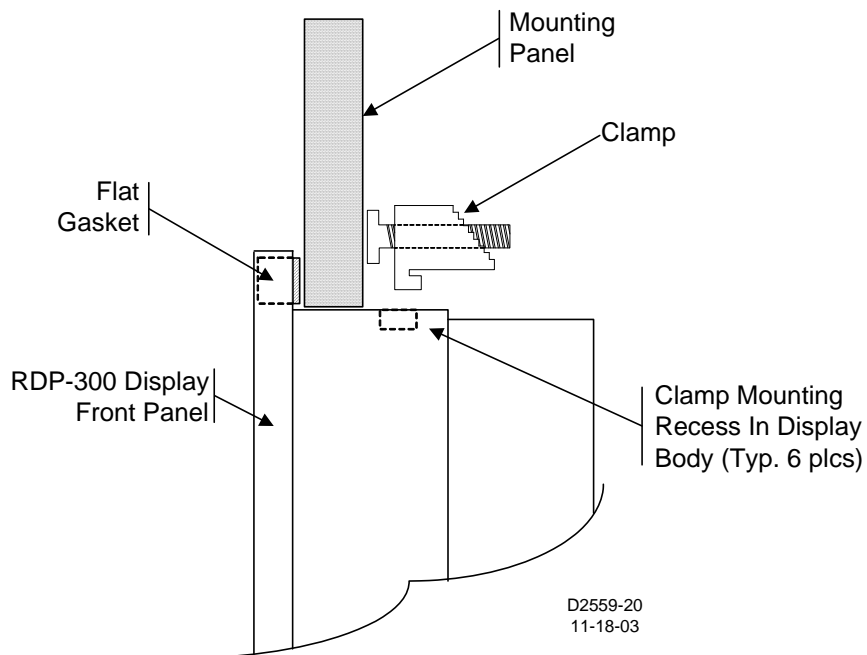
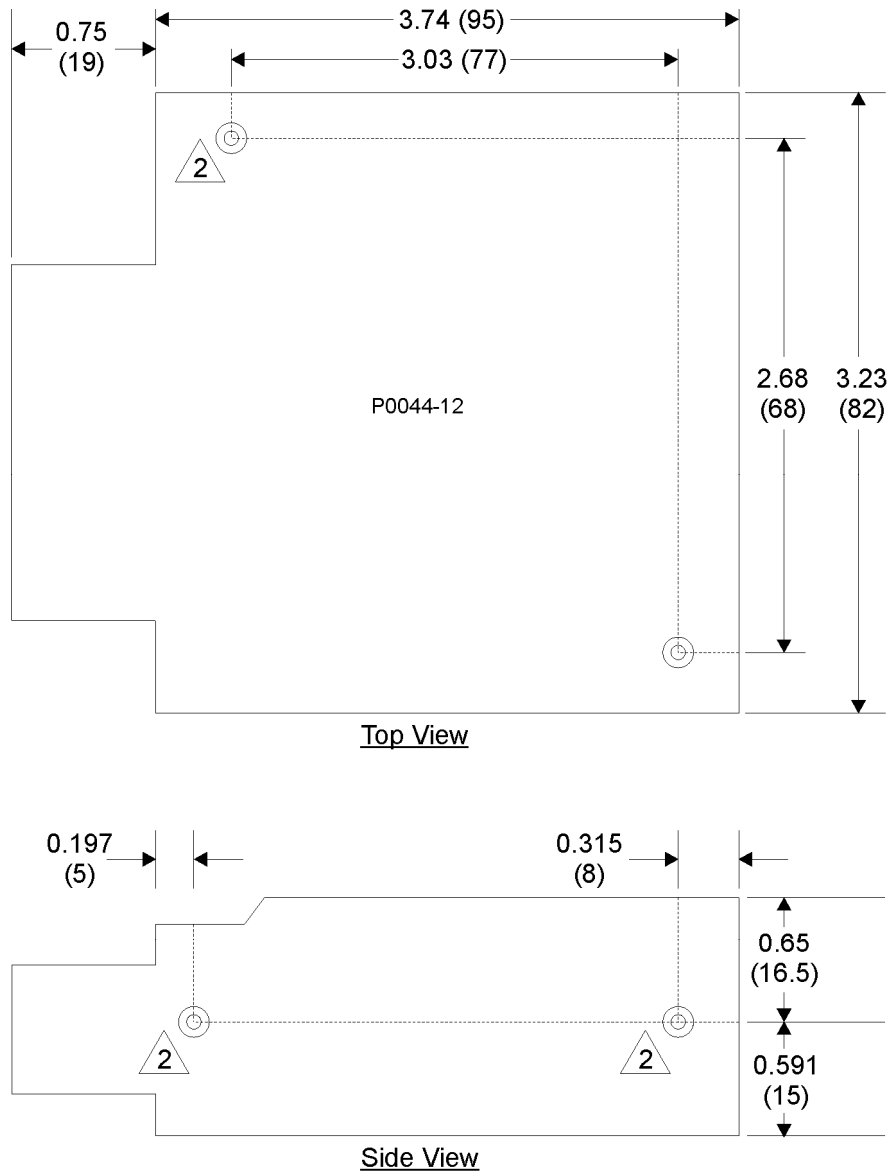

Figure 4-3. Panel Clamp Installation

## RDP-300 Power Supply

The dimensions of the optional RDP-300 power supply, part number 9334503101, are shown in Figure 4-4. Power supply connections are shown in Figure 4-5.



1. Dimensions are in inches (millimeters).

2. M3 tapped holes (2). Mounting screws must not protrude into power supply by more than 0.236 (6).

3. Weight is 220 grams (7.76 ounces).

Figure 4-4. RDP-300 Power Supply Dimensions

## CONNECTIONS

Typical RDP-300-4S connections are shown in Figure 4-5.

### NOTE

The RDP-300-4S must be connected to earth ground through a 12 AWG or larger copper wire connected to the RDP-300-4S GND terminal.

Be sure that the RDP-300-4S is wired correctly. Reversing the input power connections (V+, V-) will prevent the RDP-300-4S from operating.

Shielded, twisted-conductor cable is recommended for the RS-485 interface connections. The shield is to be connected only at the RDP-300-4S GND terminal.

A terminating resistor (120 ohms, ¼ watt or greater) must be installed across DECS-400 terminals A6 (A) and A7 (B).

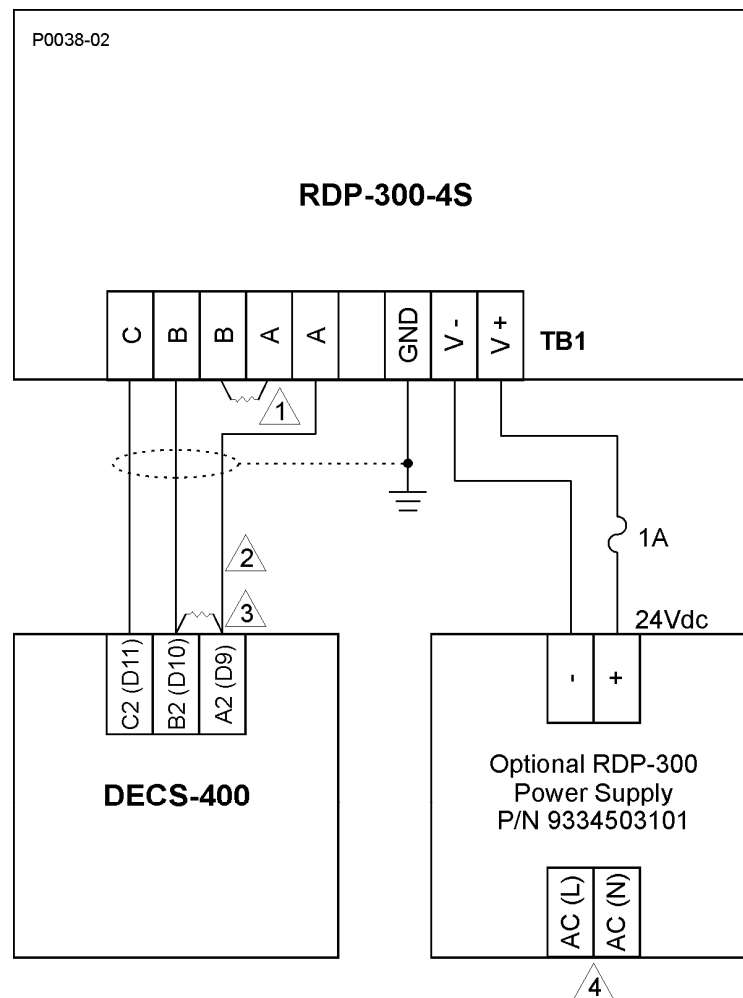

### NOTES

- 1 RDP is supplied with resistor connected to terminals A and B.
- 2 4000 ft (122 m) maximum cable length.
- 3 Required 120 ohm terminating resistor.
- 4 Accepts 85 to 265 Vac or 120 to 370 Vdc.

Figure 4-5. RDP-300-4S Typical Interconnection

## RS-485 Terminating Resistors

Terminating resistors are required at each end of the RS-485 communication loop. Terminating resistors prevent impedance mismatches from causing signal echoes and data corruption during RDP-300-4S communication. The RDP-300-4S is supplied with one terminating resistor connected across the A and B terminals. One additional resistor (not supplied) must be connected across the DECS-400 RS-485 A and B terminals as shown in Figure 4-5. The resistor should have a value of 120 ohms and a power rating of ¼ watt or greater.

---

## COMMUNICATION SETUP

Because the RDP-300-4S communication parameters are fixed, the DECS-400 communication parameters must be adjusted to match the parameters of the RDP-300-4S. Table 4-1 lists the DECS-400 parameters required for communication with the RDP-300-4S.

*Table 4-1. DECS-400 Communication Parameters*

<b>Parameter</b>	<b>Setting</b>
Address	247
Baud Rate	9600
Data Bits	8
Parity	None
Stop Bits	2

# SECTION 5 • TROUBLESHOOTING

## TROUBLESHOOTING PROCEDURES

Table 5-1 lists some RDP-300-4S operating errors along with the possible causes and remedies.

*Table 5-1. RDP-300-4S Troubleshooting Procedures*

<b>No indication on display and UNIT ACTIVE LED not lit</b>	
Possible Cause	Remedy
Low or no input voltage present at terminals V+ and V-.	Ensure that the RDP-300-4S is being supplied with 24 Vdc $\pm$ 15%. Check wiring. RDP-300-4S connections are shown in Figure 4-4.
RDP-300-4S is defective.	Replace unit.
<b>Error message “PLC NOT RESPONDING (02:FE)” is displayed</b>	
Possible Cause	Remedy
Low or no input voltage applied to the DECS-400 operating power terminals.	Check DECS-400 operating power voltage and wiring.
DECS-400 communication parameters don't match the RDP-300-4S communication parameters.	Check the DECS-400 communication port settings. DECS-400 communication parameters are listed in Table 4-1.
RS-485 communication wiring not connected.	Check wiring. RDP-300-4S connections are shown in Figure 4-4.
<b>Error message “RECEIVE DATA ERROR (02:FD)” is displayed</b>	
Possible Cause	Remedy
RS-485 communication connections are incorrect (reversed).	Check wiring. RDP-300-4S connections are shown in Figure 4-4.
<b>Error message “PLC COM ERROR (02:02)” is displayed</b>	
Possible Cause	Remedy
Incorrect DECS-400 firmware version.	Update DECS-400 firmware.

This page intentionally left blank.



ROUTE 143, BOX 269  
HIGHLAND, IL 62249 USA  
<http://www.basler.com>, [info@basler.com](mailto:info@basler.com)

PHONE +1 618-654-2341

FAX +1 618-654-2351